

Article number: 20046005

Description: E+G Cam action Indexing plunger
GN 712-8-M16x1.5-A

Measures

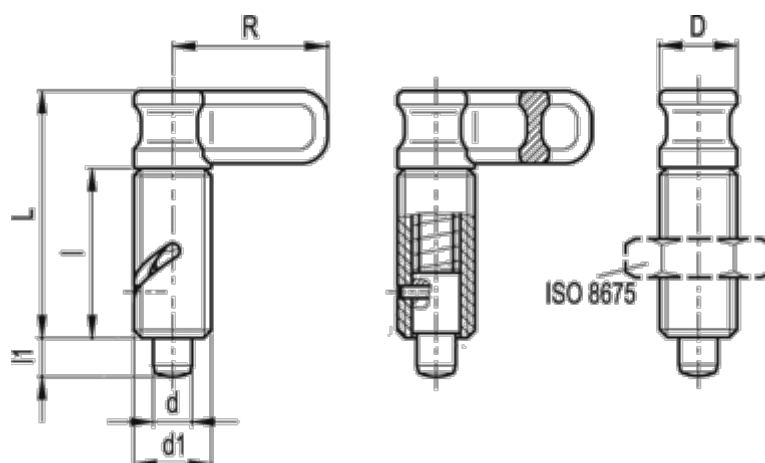

D	= 16
d -0.02 -0.04	= 8
d1	= M16x1.5
l1	= 8
L approx.	= 51
l min	= 35
R	= 32
Spring pressure end (N)	= 20

Spring pressure preload (N) = 6.5